

**LEDARRAY
INDOOR DISPLAY**

**MNS
SERIES**



® *Light Engineered Displays, Inc.*

Graphic Annunciators * Water Leak Detection
Fireman's Smoke Control Panels * ARA Systems

109 Portwatch Way Wilmington, N.C. 28412 Phone: (800) 251-2512 Fax: (800) 251-9878
Internet: www.ledinc.com Email: sales@ledinc.com

MASS NOTIFICATION SYSTEM SERIES



General Description

The LEDArray Series Indoor displays are LED message centers designed for light industrial, commercial and office use. They quickly display large amounts of information in 8 colors and 3 rainbow effects (red only versions are also available). These message centers are among the brightest and sharpest indoor displays available.

Messages are entered through a wireless, remote control keyboard, as easy to understand and use as an ordinary calculator. Exclusive 3-step message entry with Automode programming eliminates the need to learn complicated programming procedures. Within seconds, the user can create exciting visual messages that cannot be ignored. 10 preset mass notification messages are provided.

In applications requiring multiple units to communicate important information, Alpha displays can be networked and connected to a PC, to form a powerful integrated visual information system throughout your plant or business facility, or the LED Contact Interface Panel can be used for Fire Alarm or Manual type activation.

LEDARRAY



LEDArray Specifications - L.E.D. Mass Notification System

Sizes	LEDArray
Case Dimensions: (With power supply)	28.9"L x 2.1"D x 4.5"H (73.4 cmL x 5.3 cmD x 11.4 cmH)
Approximate Weight:	6.25 lbs (2.13 kg.)
Display Dimensions:	27"L x 2.1"H (68.6 cmL x 5.3 cmH)
Display Array:	90 x 7 pixels
Characters Displayed in one-line (minimum):	15 characters
Display Memory:	7,000 characters

Pixel Size (Diameter):	0.2" (.05 cm)	Serial Computer Interface:	RS232 and RS485 (multi-drop networking for up to 255 displays) Options: Ethernet LAN adapter
Pixel (LED) Color:	Red	Power:	Input: 5A, 35W, 7 VAC 120 VAC OR 230 VAC adapter available
Center-to-Center Pixel Spacing (Pitch):	0.3" (0.8 cm)	Power Cord Length:	10 Ft. (3m)
Character Size:	2.1" (4.3 cm)	Keyboard:	Handheld, Eurostyle, IR remote operated
Character Set:	Block (sans serif), decorative (serif), upper/lower case, slim/wide	Case Material:	Molded plastic
Memory Retention:	One month typical	Limited Warranty:	One-year parts and labor, factory servicing
Message Capacity:	81 different messages can be stored and displayed	Agency Approvals:	- 120 VAC Model: Power supply has UL/CSA listing. - 230 VAC Models: Complies with EN 60950: 1992 (Europe). - FCC Part 15 Class A - Marked
Message Operating Modes:	-25 consisting of: Automode, Hold, Interlock, Roll (6 directions), Rotate, Sparkle-On, Twinkle, Spray-on, Slide-Across, Switch, Wipe (6 directions), Starburst, Flash, Snow, Scroll Condensed Rotate -Continuous message entry with automatic centering in any mode -User programmable logos and graphics - Five hold speeds	Operating Temperature:	32°to 120°F, 0°to 49°C
Built-in Animations:	Cherry Bomb Exploding, Don't Drink and Drive, Fireworks, Slot Machine, No Smoking, Running Animal, Moving Auto, Welcome and Thank You	Humidity Range:	0% to 95% non-condensing
Real-Time Clock:	Date and time, 12 or 24 hour format, maintains accurate time without power for up to 30 days typical	Mounting:	Hardware to accommodate ceiling or wall mounting

POWER REQUIREMENTS

Signs require 115 VAC input power for the plug-in transformer. Use an Exit Sign branch circuit for power. Power consumption @ 115 VAC: Approximately 113 ma in standby mode & Approximately 300 ma typical message.

LEDArray Mounting Instructions







Model (weight)	Mounting Instructions		
	Wall	Ceiling	Counter
PPD (1 lb 5 oz, 595.35 g)	 <p>Ceiling mounts 9 3/8" (23.8 cm) apart</p> <p>Wall mounting holes 4" (10.2 cm) apart</p>	 <p>The mounting bracket and screws are included.</p>	 <p>The mounting bracket and screws are included.</p>
LEDArray (6.25 lb, 2.83 kg)	 <p>◀ Flip-up ceiling mounts 24" (61 cm) apart ▶</p> <p>Wall mounting holes 24" (61 cm) or 16" (40.6 cm) apart or</p> <p>A mounting kit can be used to mount the sign on a wall, ceiling, or counter. (The kit contains brackets that attach to the end of the sign and can swivel.)</p>	<p>The flip-up ceiling mounts will come out if the sign is turned over.</p> 	<p>The sign will stand up if placed on a counter. However, for greater stability, use a mounting kit.</p>
MegaDot (12.25 lbs, 5.6 kg)	<ol style="list-style-type: none"> Attach two wall brackets in the mounting kit to a wall 46 3/4" (118.7 cm) apart. (measured from the center of each bracket). Attach the mounting brackets to the sign as shown.  <p>Wall mounting distance</p> <p>Lock washers</p>	<p>Using the mounting kit and a chain (not supplied in the kit), mount the sign from the ceiling as shown:</p> 	<p>The sign will stand up if placed on a counter. However, for greater stability, use the mounting kit:</p> 

FIG.	P/N	DESCRIPTION
A	---	Ferrite: Insert the end of the 4-conductor data cable (B) with the ferrite core into the RJ11 port on the electronic display - the ferrite core must be closer to the electronic display than it is to the modular network adapter.
B	MNS-Cable	RS485 1ft cable RS485 8ft cable
C	MNS-Adpt	Modular Network Adapter
*D	MNS-Cntr	Contact Monitor & Sign Controller

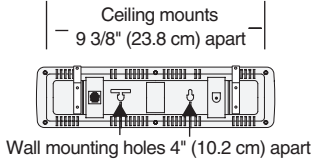
See Pg. 4 Figure 1
*See Pg. 6 Enclosures

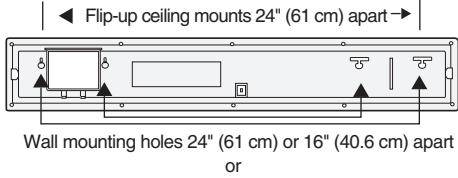
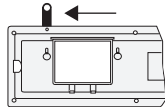
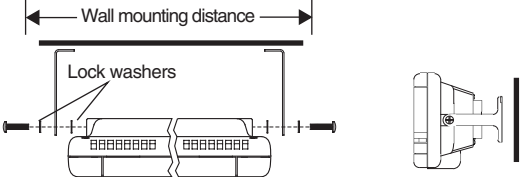
BEFORE MOUNTING A SIGN, REMOVE POWER FROM THE SIGN!

⚠ WARNING



Hazardous voltage.
Contact with high voltage may cause death or serious injury.
Always disconnect power to sign prior to servicing.

NOTE: LEDArray signs are for indoor use only and should not be continuously exposed to direct sunlight.

NOTE: Mounting hardware that is used to hang or suspend a sign must be able of supporting at least 4 times the weight of the sign.

DRY CONTACTS TO RS-485 DATA INTERFACE

Model: MNS-ctrl - for LEDArray and MegaDot signs

The ALPHA Discrete Input Interface allows messages to be displayed on standard LEDArray electronic signs by using simple on/off contacts to trigger messages that have been stored in a sign. The ALPHA Discrete Input Interface is designed for low-voltage applications.

Messages to be displayed are stored in a sign using either:

- Infrared handheld remote control
- Adaptive software such as ALPHA Messaging software

CPU / Input Module — serves as an interface between the Input Modules and LEDArray signs.

Up to four Input modules can be used, depending on the Operating Mode used. The eight, dry contact inputs of each Input Module can be configured to one of five possible Operating Modes:

- Mode 0: Discrete Fixed
- Mode 1: Momentary Triggered
- Mode 2: Binary Coded Decimal (BCD)
- Mode 3: Binary
- Mode 4: Counter

Power Module *not shown* — supplies power to the CPU Module / Input Modules

Figure 1
(see component descriptions on other side)

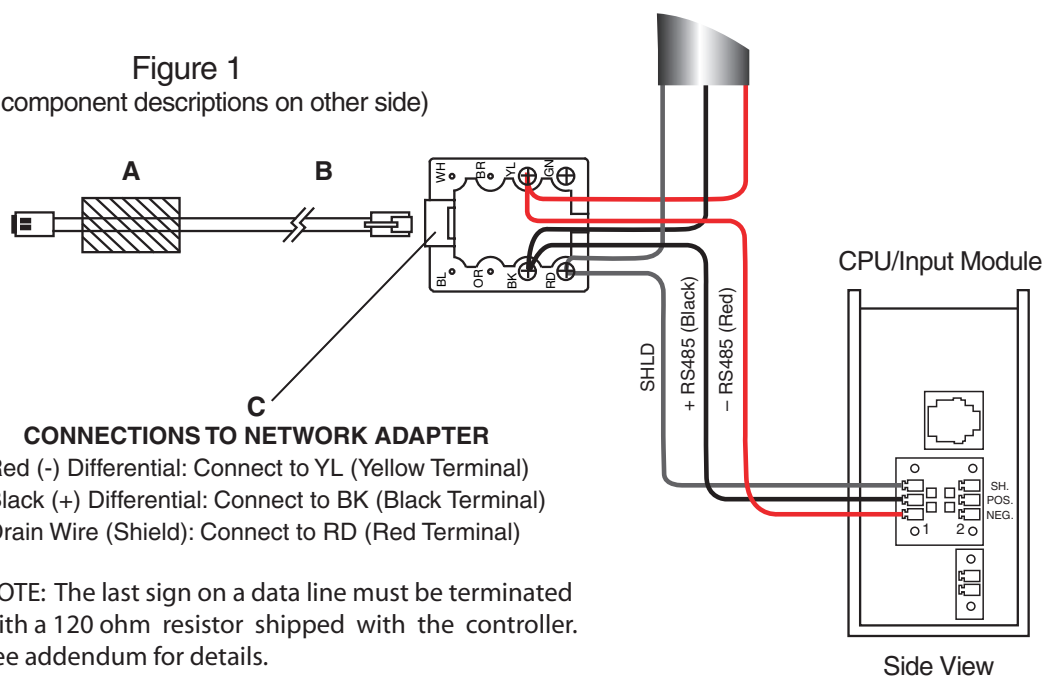

These modules are installed in a 12"x12"x4" deep box with a hinged door and cam lock to prevent unauthorized access. The inputs to the modules are pre-wired to terminal blocks for easy installation. A pair of wires from your dry contact(s) is all that is needed to activate the associated message(s). The messages are pre-programmed but can easily be changed with a hand-held remote or laptop computer.

Operating Modes

NOTE: Only one Operating Mode can be used at a time. For example, if three Input Modules were connected together, all three modules would have to use the same Operating Mode.

Discrete Fixed (Mode Ø)

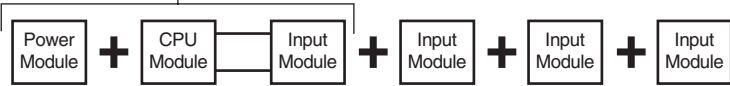
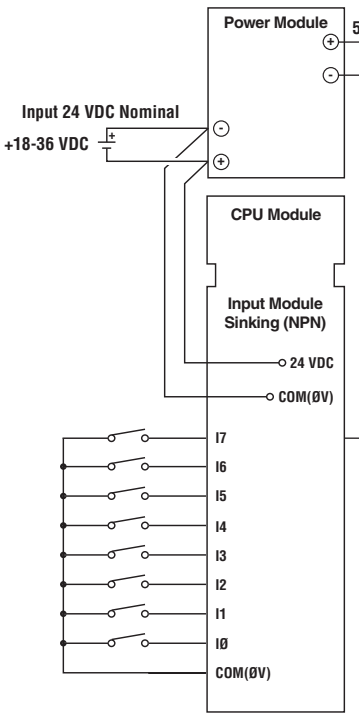
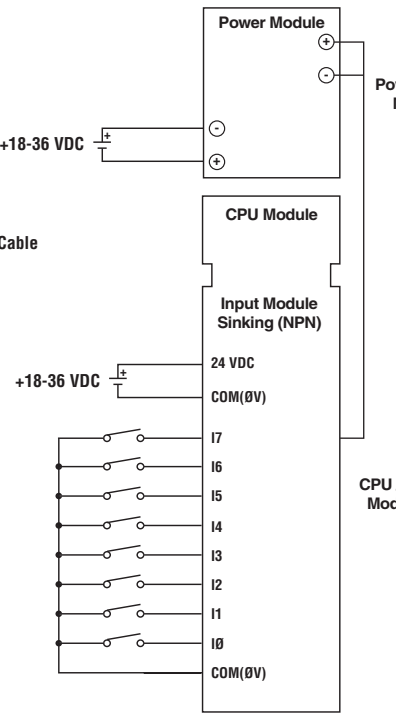
Description:	When an input (IØ - I7) is high, the associated sign message is displayed. It is possible to have several messages running simultaneously on a sign.												
Module configuration:	<p style="text-align: center;">Minimum configuration</p>  <p style="text-align: center;">Input Module internal jumper settings:</p> <table border="1" style="margin-left: auto; margin-right: auto;"> <tr> <td>AØ = Ø</td> <td>AØ = 1</td> <td>AØ = Ø</td> <td>AØ = 1</td> </tr> <tr> <td>A1 = Ø</td> <td>A1 = Ø</td> <td>A1 = 1</td> <td>A1 = 1</td> </tr> <tr> <td>A2 = Ø</td> <td>A2 = 1</td> <td>A2 = 1</td> <td>A2 = 1</td> </tr> </table>	AØ = Ø	AØ = 1	AØ = Ø	AØ = 1	A1 = Ø	A1 = Ø	A1 = 1	A1 = 1	A2 = Ø	A2 = 1	A2 = 1	A2 = 1
AØ = Ø	AØ = 1	AØ = Ø	AØ = 1										
A1 = Ø	A1 = Ø	A1 = 1	A1 = 1										
A2 = Ø	A2 = 1	A2 = 1	A2 = 1										
Maximum no. of messages:	32												
Maximum no. of inputs:	32 (8 inputs per module x 4 Input Modules connected)												
Sinking (NPN) circuit:	<div style="display: flex; justify-content: space-around;"> <div style="text-align: center;"> <p>NON-ISOLATED</p>  </div> <div style="text-align: center;"> <p>ISOLATED</p>  </div> </div> <p style="text-align: center; margin-top: 10px;">COM(ØV) is internally connected. 24 VDC is internally connected.</p>												
<p>NOTES: Standby current is 83ma plus 20ma for each activated message. All Input Modules are internally fused. Wire the modules according to local electrical code.</p>													

Connecting Using RS-485 Network

Networking one or more signs (shielded)

NOTE: When signs are networked to the CPU Module, all the signs must be the same model when ALPHA Messaging software is used.

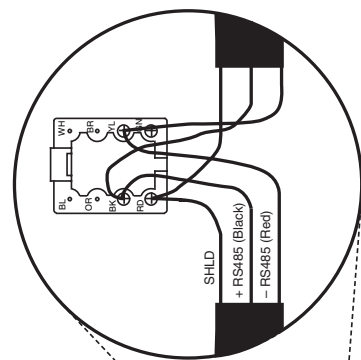

- Connect RED wire from RS485 cable to YL screw.
- Connect BLACK wire from RS485 cable to BK screw.
- Connect SHIELD wire from RS485 cable to RD screw if the sign is a Series 4000 or Series 7000. Otherwise, connect the two SHIELD wires to each other, but **not** to the RD screw.

LEDARRAY
Mass Notification Signs
Connecting using RS-485 Network.

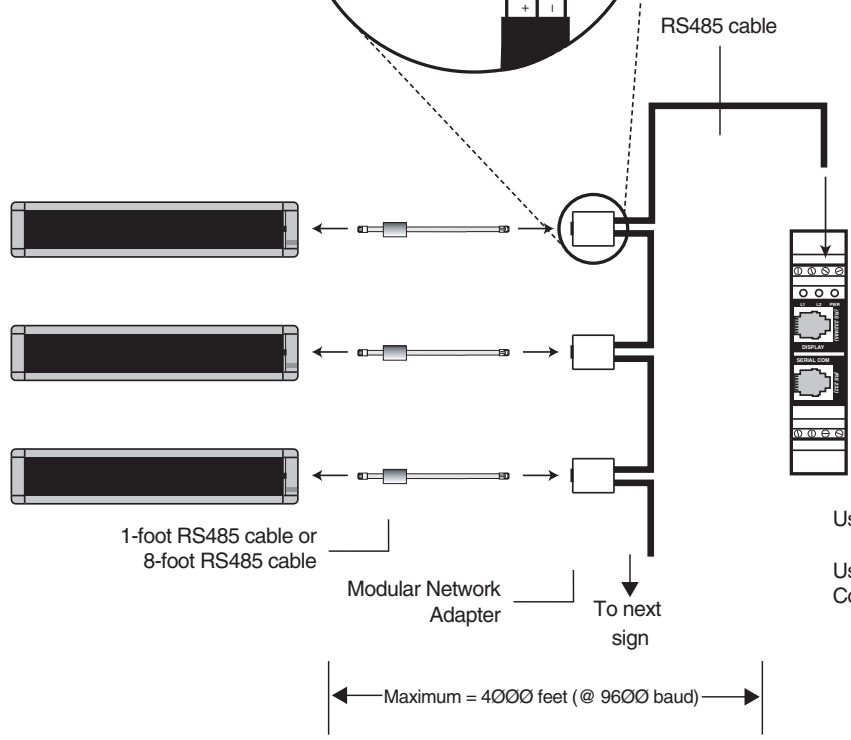

See Figure 1
Page 4

Use a twisted pair, 22awg with common shield.
Use modular adapter for network wiring.
Connect to sign with RJ-11 cable.

Enclosures

